



HPU HANDING CONFIRMATION

SO NUMBER (INTERNAL USE)		WO NUMBER (INTERNAL USE)	
------------------------------------	--	------------------------------------	--

ROOF TOP PACKAGED UNITS (RTU)

MODELS	All
GENERAL	This document details the airside configurations available on all HPU models.
SOURCING	Standard configuration is detailed in the unit general arrangement drawings. Optional airside configurations to be specified at time of order.
HOW TO USE THIS DOCUMENT	<ol style="list-style-type: none"> 1. Choose if the supply air fan position is required on the left or right. 2. Circle the required supply air outlet. 3. Circle the required return air inlet. 4. Complete the information at the bottom of this document and return to your APAC representative.

LEFT HAND SUPPLY AIR (STANDARD)	RIGHT HAND SUPPLY AIR (OPTIONAL)
---------------------------------	----------------------------------

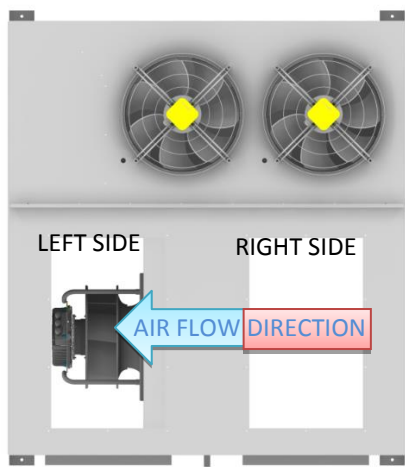

Fig1. Left hand unit from the top view

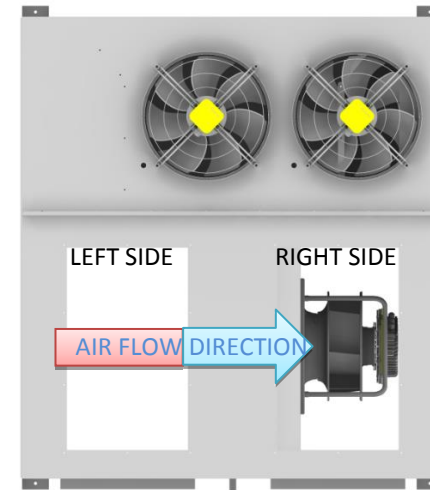

Fig3. Right hand unit from top view

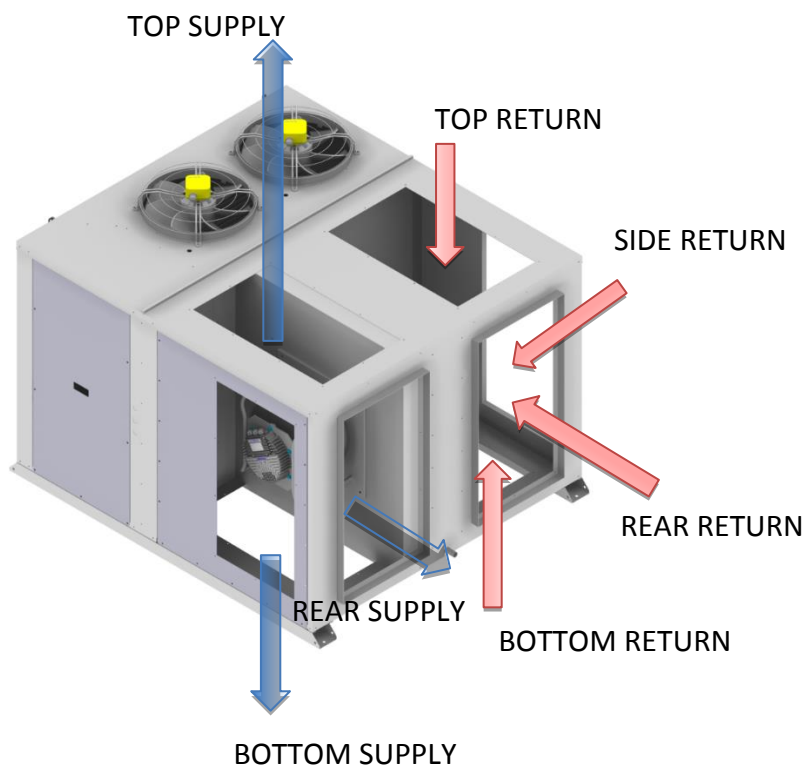

Fig2. Air flow schematic of the left hand unit

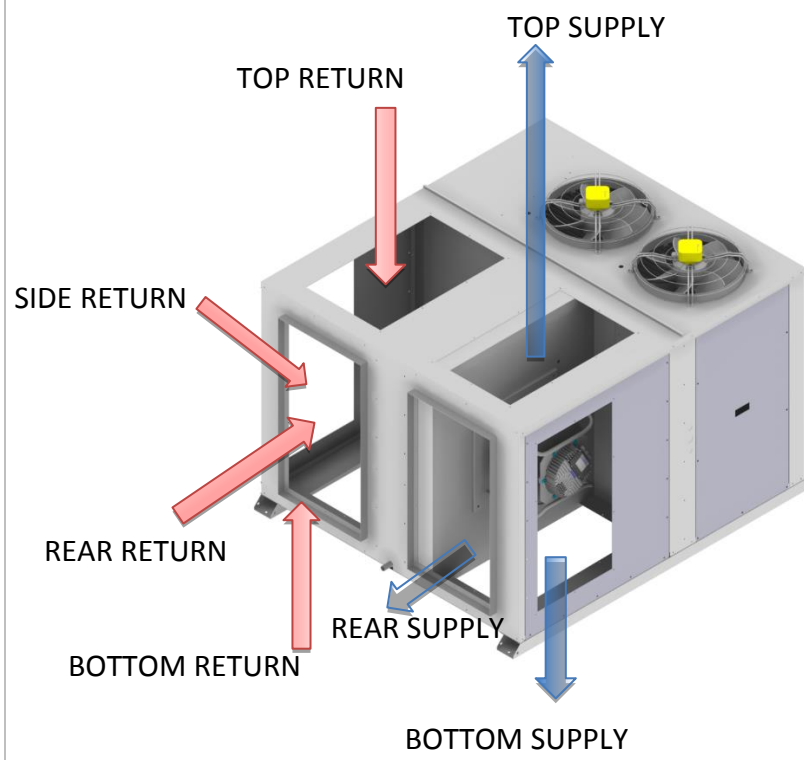
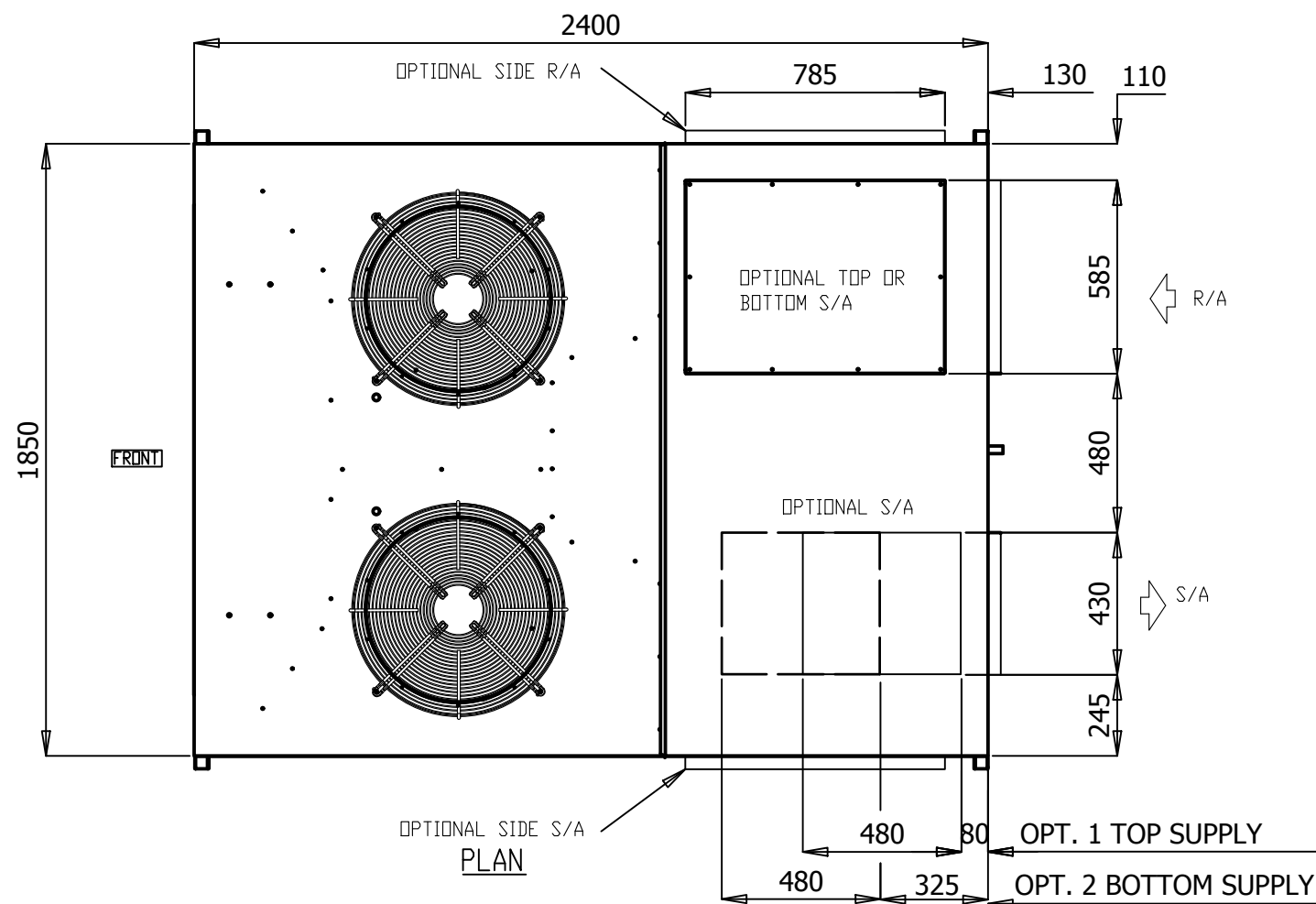

Fig 4. Air flow schematic of the right hand unit

CUSTOMER TO COMPLETE AND RETURN

CUSTOMER	PROJECT	UNIT REF	NAME / SIGN	DATE



NOTES:

1. GENERAL ARRANGEMENT OF A HORIZONTAL AIR COOLED PACKED UNIT
2. POWER AND FIELD CABLE ENTRIES, 1 x 32 ϕ AND 2 x 25 ϕ
3. ELECTRICAL PANEL LOCATED BEHIND SERVICE ACCESS
4. CONDENSATE OUTLET 25 ϕ
5. UNIT BASE 4 x 16 ϕ FIXING POINTS
6. UNIT HAS 4 x 20 ϕ LIFTING POINTS
7. UNIT CONFIGURATION AS STANDARD IS REAR LEFT SUPPLY, REAR RIGHT RETURN, OTHER CONFIGURATIONS AVAILABLE.
8. UNIT CONFIGURATION CAN BE CONVERTED IN FIELD WITH OPTIONAL ACCESSORIES.

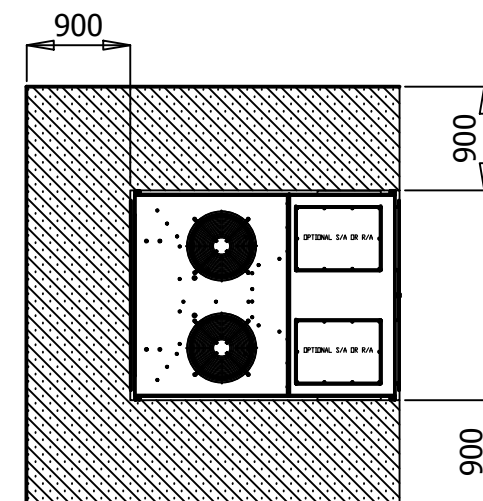
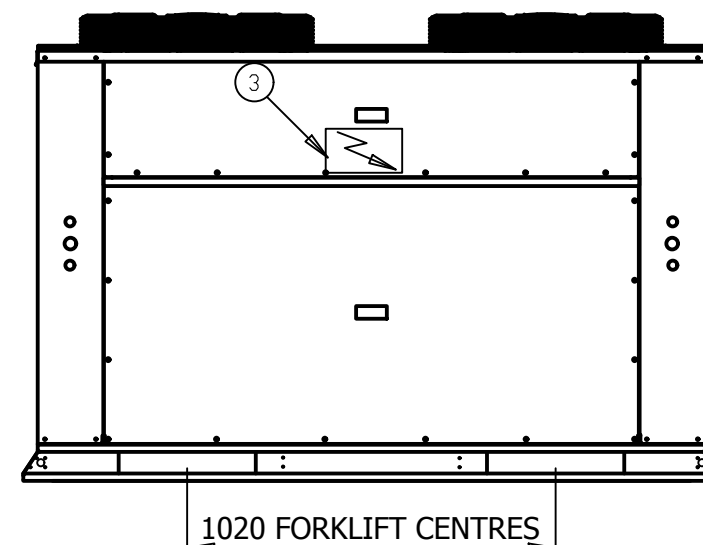

FRONT ELEVATION

CLEARANCE DETAIL

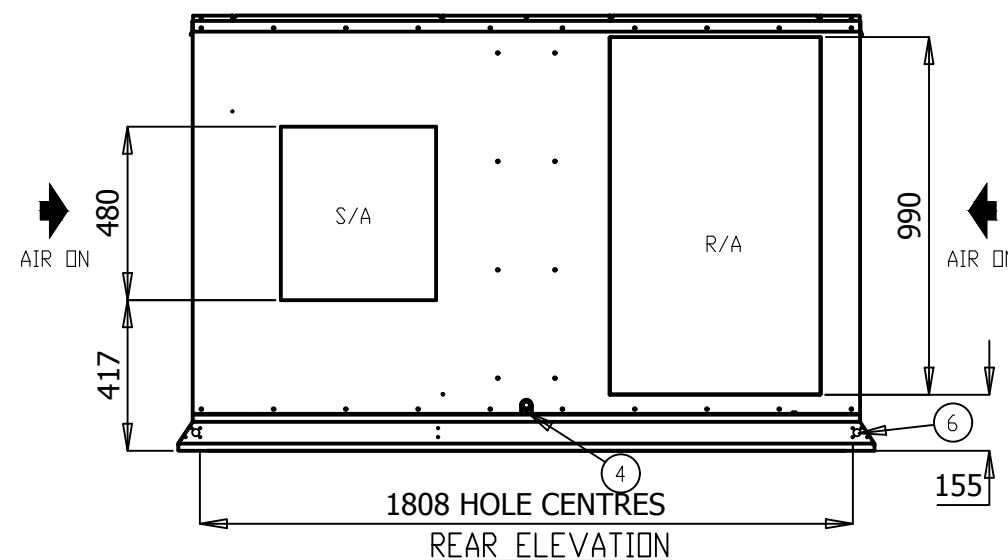
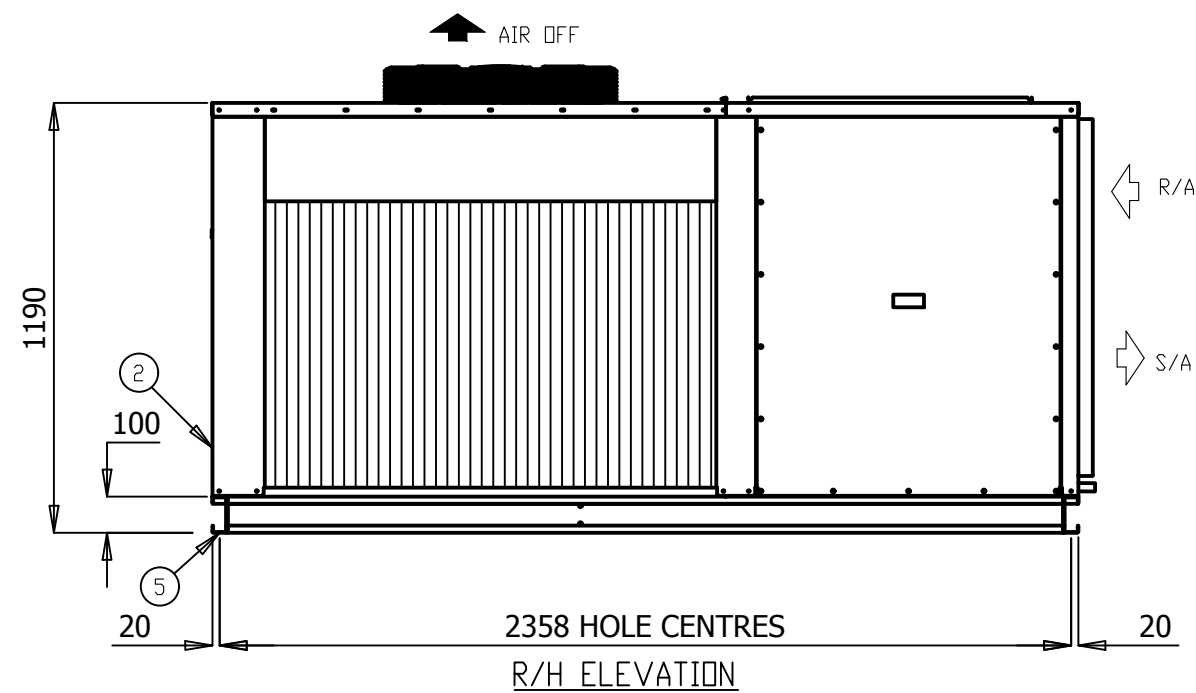

R/H ELEVATION

REAR ELEVATION

- ALL DIMENSIONS IN mm.
- GENERAL TOLERANCE ± 1 mm.
- DO NOT SCALE DRAWING.
- MASTER DRAWINGS ARE HELD ELECTRONICALLY. ANY COPY IS DEEMED UNCONTROLLED AND THEREFORE NOT NECESSARILY THE LATEST REVISION.
- ALL INFORMATION REMAINS THE PROPERTY OF THE COMPANY.

GENERAL ARRANGEMENT

P045AHR3SA-

www.apacair.com.au

ABN: 74 005 138 769

REVISION	REVISED NAMEPLATE WITH APAC DETAILS				
		DRAWN	MT	DRAWING No.	A4
	ATLANTIC DR. KEYSBOROUGH VIC 3173 1300 555 545	DATE	13.07.17	GAD0091	
		SCALE	N.T.S.		
		CHECKED	HA	APP'D.	CM



TECHNICAL DATA SHEET

MODEL NUMBER	P024AHR3SA-	P030AHR3SA-	P035AHR3SA-	P040AHR3SA-	P045AHR3SA-		
MEPS REGISTRATION NUMBER	AAC3198	AAC3199	AAC3127	AAC3207	AAC3216		
CONDENSER SECTION	CAPACITY						
	Cooling	kW TOTAL*	25.14	30.82	34.08	39.76	44.78
		kW SENSIBLE*	19.38	26.23	28.49	33.32	37.57
		EER (kW / ikW)*	3.59	3.67	3.47	3.29	3.14
	Heating	kW TOTAL	23.80	30.20	33.60	40.10	42.90
		COP	3.66	3.59	3.61	3.61	3.77
	CAPACITY STEPS (%)	50/100	50/100	50/100	50/100	50/100	
	COMPRESSOR						
	TYPE	SCROLL	SCROLL	SCROLL	SCROLL	SCROLL	
	STARTER TYPE	D.O.L (Opt Soft/Start)	D.O.L (Opt Soft/Start)	D.O.L (Opt Soft/Start)	D.O.L (Opt Soft/Start)	D.O.L (Opt Soft/Start)	
	PHASE	3Ø	3Ø	3Ø	3Ø	3Ø	
	No. OFF	2	2	2	2	2	
	PROTECTION DEVICES	HP SWITCH, LP SWITCH, MOTOR OVERLOAD'S					
	ALL COMPRESSORS HAVE	CRANKCASE HEATER					
	FAN						
	TYPE	AXIAL	AXIAL	AXIAL	AXIAL	AXIAL	
	ikW (MAX INPUT)	0.39	0.39	0.39	0.60	0.60	
	PHASE	1Ø	1Ø	1Ø	1Ø	1Ø	
	No. OFF	2	2	2	2	2	
	FAN SPEED CONTROL	VARIABLE SPEED	VARIABLE SPEED	VARIABLE SPEED	VARIABLE SPEED	VARIABLE SPEED	
	HEAT EXCHANGER						
	TYPE	PLATE FIN COIL	PLATE FIN COIL	PLATE FIN COIL	PLATE FIN COIL	PLATE FIN COIL	
	NOM. AIRFLOW l/s	-	-	-	-	-	
REFRIGERANT SYSTEM							
TYPE	R410A						
CHARGE PER CIRCUIT (KG)	3.95	5.3	5.7	7.3	6.8		
No. OF CIRCUITS	2	2	2	2	2		
REFRIGERANT CONTROL	TXV						
ALL SYSTEMS INCLUDE	DRIERS & SIGHT GLASSES						
EVAPORATOR SECTION	FAN						
	TYPE	CENTRIFUGAL	CENTRIFUGAL	CENTRIFUGAL	CENTRIFUGAL	CENTRIFUGAL	
	ikW (MAX INPUT)	2.73	2.73	2.73	3	3	
	PHASE	3Ø	3Ø	3Ø	3Ø	3Ø	
	No. OFF	1	1	1	1	1	
	FAN SPEED CONTROL	VARIABLE SPEED	VARIABLE SPEED	VARIABLE SPEED	VARIABLE SPEED	VARIABLE SPEED	
	HEAT EXCHANGER						
	TYPE	PLATE FIN COIL	PLATE FIN COIL	PLATE FIN COIL	PLATE FIN COIL	PLATE FIN COIL	
NOM. AIRFLOW l/s	1250	1600	1780	2080	2380		
EXT STATIC pa	100 (ALL FANS ARE HIGH STATIC FANS. REFER TO FAN CURVES.)						
COMBINED SECTIONS	ELECTRICAL						
	MAINS POWER	415v / 3Ø / 50hz	415v / 3Ø / 50hz	415v / 3Ø / 50hz	415v / 3Ø / 50hz	415v / 3Ø / 50hz	
	H.P. CUT OUT / IN kPa	4500 / 3450	4500 / 3450	4500 / 3450	4500 / 3450	4500 / 3450	
	L.P. CUT OUT / IN kPa	175 / 345	175 / 345	175 / 345	175 / 345	175 / 345	
	NOM. R.L.A. (TOTAL SYSTEM)	13.6	15.9	19.4	20.7	23.0	
	MAX. F.L.A. (TOTAL SYSTEM)	23.8	28.4	31.4	39.8	39.8	
	GENERAL						
	CABINET	GALVANISED SHEET STEEL					
	INSULATION	ALUMINIUM FOIL FACED POLYETHYLENE ACOUSTIC INSULATION					
	EXTERNAL FINISH	POLYESTER POWDER COAT - COLOUR LIGHT GREY AS STANDARD - OPTIONS AVAILABLE					
	DIMENSIONS						
	H X W X D (mm)	1190 x 1850 x 2400					
	WEIGHT						
	OPERATING KG	615	625	635	648	650	
	SHIPPING KG	620	630	640	653	655	
NOISE LEVELS [Based on condenser fan's sound data]							
Sound Power db(A)	66.5	66.5	66.5	66.3	66.3		

Note: Rated in accordance with Australian standard AS/NZS 3823.1:2012
 Performance excludes ikW of evaporator fan motor.
 R.L.A - Run Load Amps are based on current drawn at nominal conditions
 F.L.A - Full Load Amps are based on the overload settings [Max Current] of all Compressor and Fan Motor(s).

Date	Document #	Approved By	Revision
31/5/18	TDS0017	CM	F

NOTE: Due to continuous improvement Rinnai Australia Pty Ltd reserve the right to change details without notice.

FAN PERFORMANCE CURVE

P045AHR3SA-

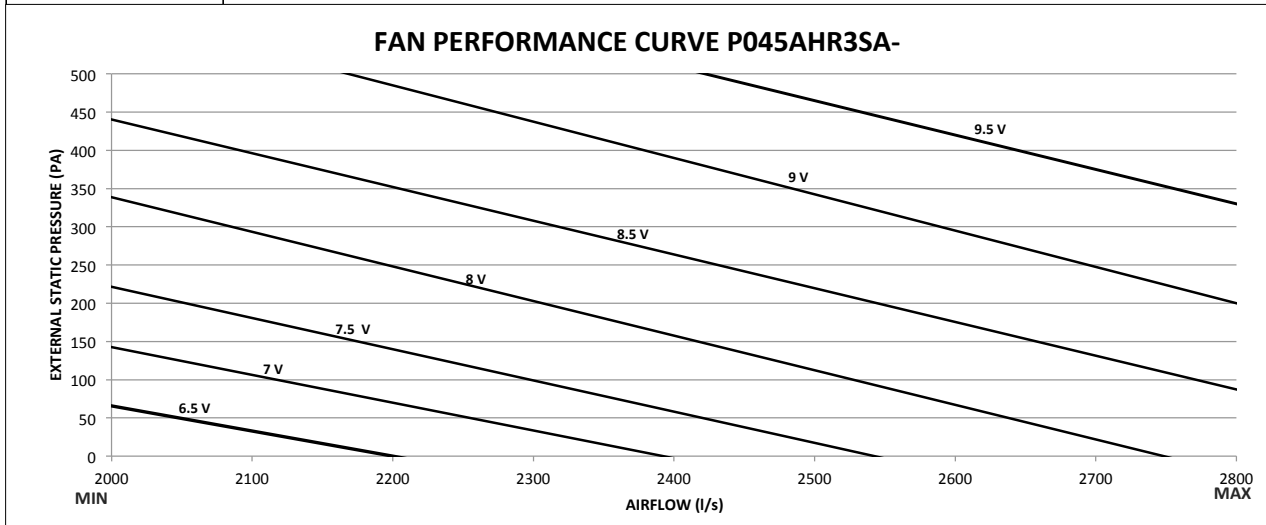

Note:

1. 6.5V, 7V, 7.5V, 8V, 8.5V, 9V and 9.5V represents potentiometer voltage. Potentiometer can be adjusted to achieve desired flowrates.
2. Potentiometer voltage can be varied infinitely between 0 to 10V.

Date	Document #	Approved By	Revision
28.05.18	FPC0018	CM	E

NOTE: Due to continuous improvement Specialized Engineering Pty Ltd reserve the right to change details without notice.



SOUND DATA

MODEL NUMBER

P045AHR3SA-

Outdoor Fan

Sound Power Level dB(A)	Octave band Centre Frequency (Hz), dB						
	125	250	500	1k	2k	4k	8k
66.8	71.8	62.5	61.6	61.4	59	54.6	52.8

Indoor Fan

Sound Power Level dB(A)	Air Flow (l/s)	Octave band Centre Frequency (Hz), dB						
		125	250	500	1k	2k	4k	8k
90.8	2380	75.3	81.9	85.3	85.2	83.7	84.1	78.4

Date	Document #	Approved By	Revision
31.05.18	SD0009	CM	C

NOTE: Due to continuous improvement Rinnai Australia Pty Ltd reserve the right to change details

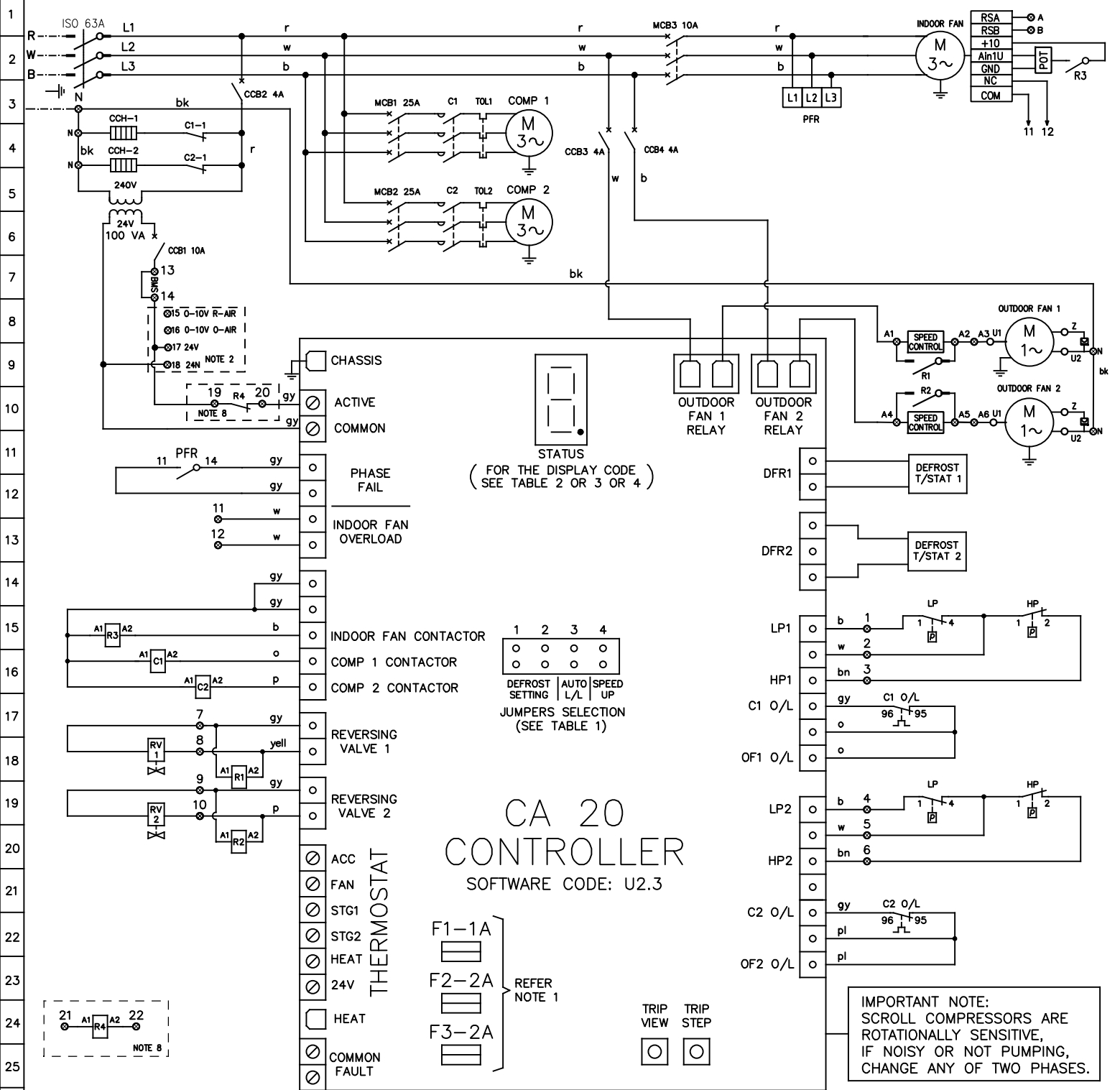

CA 20 CONTROLLER

SOFTWARE CODE: U2.3

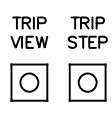
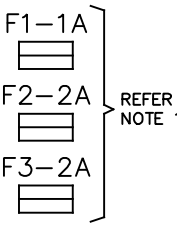
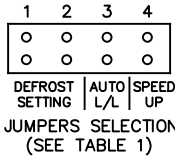

IMPORTANT NOTE:
SCROLL COMPRESSORS ARE ROTATIONALLY SENSITIVE, IF NOISY OR NOT PUMPING, CHANGE ANY OF TWO PHASES.

WARNING! THE SOFTWARE OF THE CA20 CONTROLLER IS NOT DESIGNED TO FUNCTION AS A PRIMARY PERSONAL SAFETY DEVICE, AS CONNECTED EQUIPMENT CAN START AUTOMATICALLY WITHOUT WARNING. ALSO, OPENING THERMOSTAT CONTACTS MAY NOT CAUSE THE EQUIPMENT TO STOP. OUTDOOR FAN MOTORS HAVE INTERNAL OVERLOADS AND MAY RESTART AUTOMATICALLY.

- NOTES:**
- TIME DELAY GLASS FUSES ON THE PCB CONTROLLER ARE THE FOLLOWING:
 - F1 PROTECTS THE THERMOSTAT CIRCUIT.
 - F2 PROTECTS THE REVERSING VALVE CIRCUITS AND THE "HEAT" OUTPUT. THIS FUSE F2 ALSO SUPPLIES FUSE F1.
 - F3 PROTECTS BOTH COMPRESSOR CONTACTOR CIRCUITS AND THE INDOOR FAN CONTACTOR CIRCUIT.
 - OPTIONAL 24VAC POWER SUPPLY AND 0-10V TERMINALS FOR ECONOMY CYCLE DAMPER MOTORS
 - HP CUT OUT & LP CUT OUT - AUTO RESET.
 - THERMAL OVERLOAD RELAYS - AUTO RESET, UNLESS OTHERWISE STATED.
 - DO NOT CONNECT ANY ADDITIONAL EQUIPMENT TO THE CONTROL TRANSFORMER OTHER THAN THE EQUIPMENT SHOWN ON THE ELECTRICAL DRAWING.
 - ALL FIELD WIRING IS THE RESPONSIBILITY OF THE INSTALLING CONTRACTOR AND MUST COMPLY WITH AS/NZS 3000 AND LOCAL RULES.
 - SOFTWARE CODE MUST BE CHECKED AFTER REPLACEMENT OF THE CA-20 CONTROLLER BY CHECKING THE DISPLAY CODE ON THE 7 SEGMENT DISPLAY AFTER THE CONTROLLER IS ACTIVATED.
 - OPTIONAL FIRE ALARM RELAY

JUMPERS SELECTION	DEFROST INTERVAL TIME SETTING	JUMPERS SELECTION	AUTO LEAD/LAG	JUMPERS SELECTION	SPEED UP
1 2 ○ ○	15 min	3 ○	OFF	4 ○	OFF
1 2 ■ ○	FACTORY SETTING 30 min	3	ON	4	ON
1 2 ■ ■	45 min	3	ON	4	ON

UNIT MUST BE SWITCHED OFF BEFORE CHANGING THE JUMPER SELECTION

LEGEND		LEGEND		COLOUR CODE		COMPRESSOR (EACH)		MODEL: P045AHR3SA	
○	TERMINAL SWITCHBOARD	TOL	THERMAL OVERLOAD RELAY	r	RED	KW	5.52	OPTIONS	
⊗	TERMINAL	R	CONTACTOR	w	WHITE	RATED CURRENT	15.00	DESCRIPTION	
- - -	FIELD WIRING	C	OUTDOOR FAN	b	BLUE	O/L SETTING	16.50	STANDARD	
- - -	CONTROL PARAMETER	COMP	COMPRESSOR	bk	BLACK	FANS (EACH)	KW	FLA	
- - -	MAINS/CONTROL WIRING	ISO	ISOLATOR SWITCH	bn	BROWN	OUTDOOR	0.60	2.62	
CCH	CRANK CASE HEATER	MCB	MINIATURE CIRCUIT BREAKER	o	ORANGE	INDOOR	2.86	4.30	
PFR	PHASE FAILURE RELAY	CCB	CONTROL CIRCUIT BREAKER	p	PINK				
RV	REVERSING VALVE	CCB	CONTROL CIRCUIT BREAKER	pl	PURPLE				
HP	HIGH PRESSURE SWITCH	O/L	OVERLOAD	gy	GREY				
LP	LOW PRESSURE SWITCH	POT	POTENTIOMETER	yell	YELLOW				

apac
by Riisani

DATE	20/06/2018		
DWN	S.P	APPD	ENG
REV	A	GRID	B56
DWG No.	EWS02053		