



HPU HANDING CONFIRMATION

SO NUMBER (INTERNAL USE)	WO NUMBER (INTERNAL USE)
------------------------------------	------------------------------------

ROOF TOP PACKAGED UNITS (RTU)

MODELS	All
GENERAL	This document details the airside configurations available on all HPU models.
SOURCING	Standard configuration is detailed in the unit general arrangement drawings. Optional airside configurations to be specified at time of order.
HOW TO USE THIS DOCUMENT	<ol style="list-style-type: none"> 1. Choose if the supply air fan position is required on the left or right. 2. Circle the required supply air outlet. 3. Circle the required return air inlet. 4. Complete the information at the bottom of this document and return to your APAC representative.

LEFT HAND SUPPLY AIR (STANDARD)

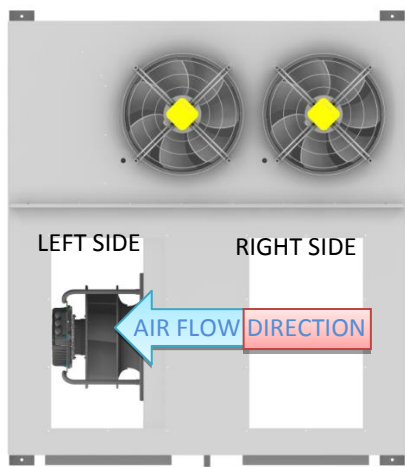

Fig1. Left hand unit from the top view

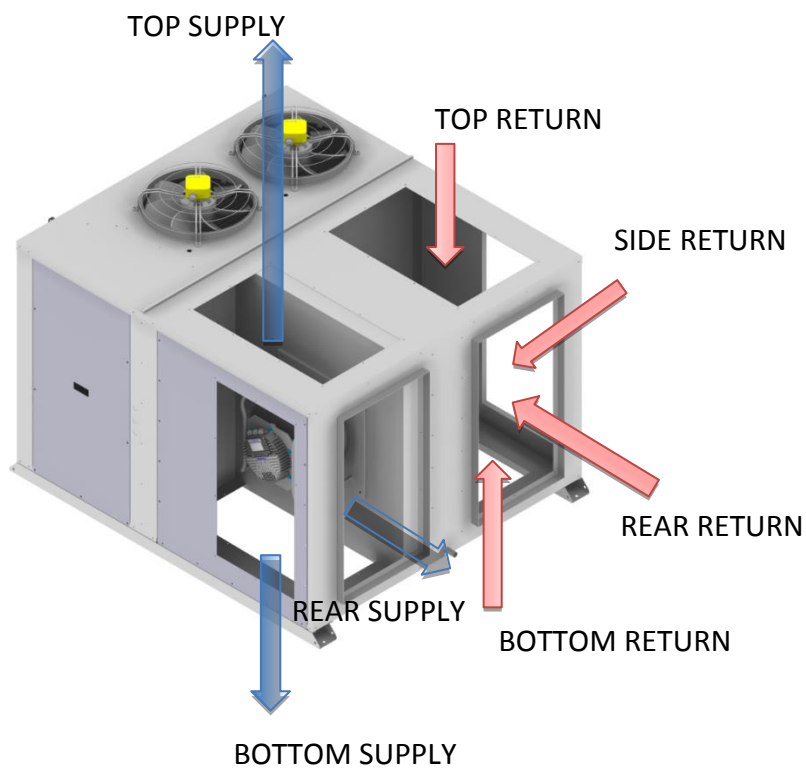

Fig2. Air flow schematic of the left hand unit

RIGHT HAND SUPPLY AIR (OPTIONAL)

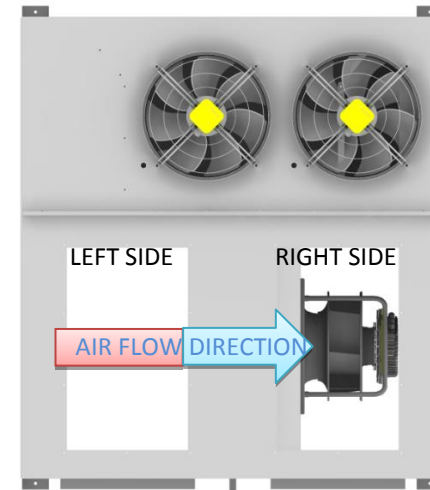

Fig3. Right hand unit from top view

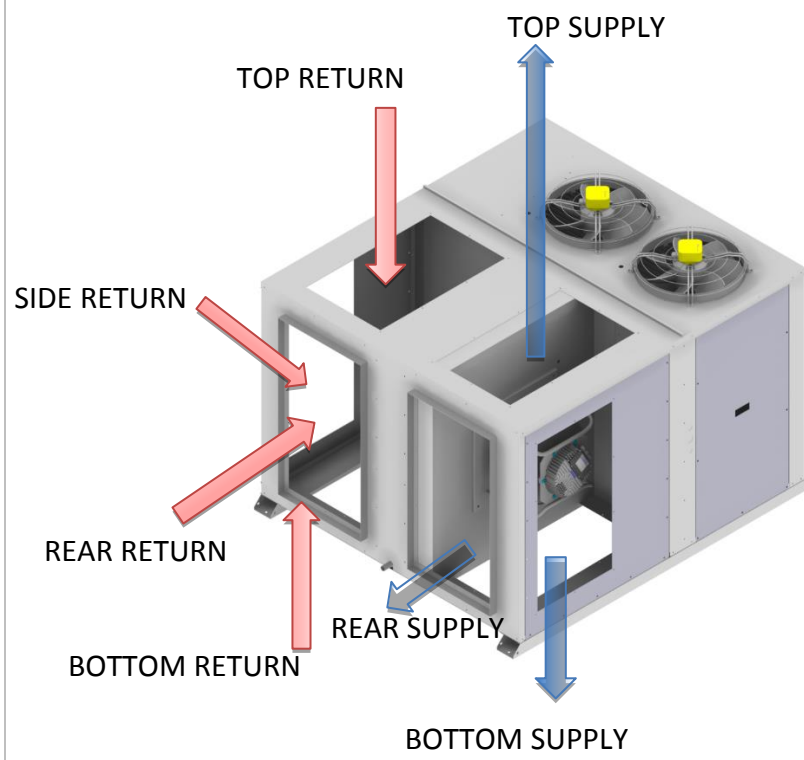
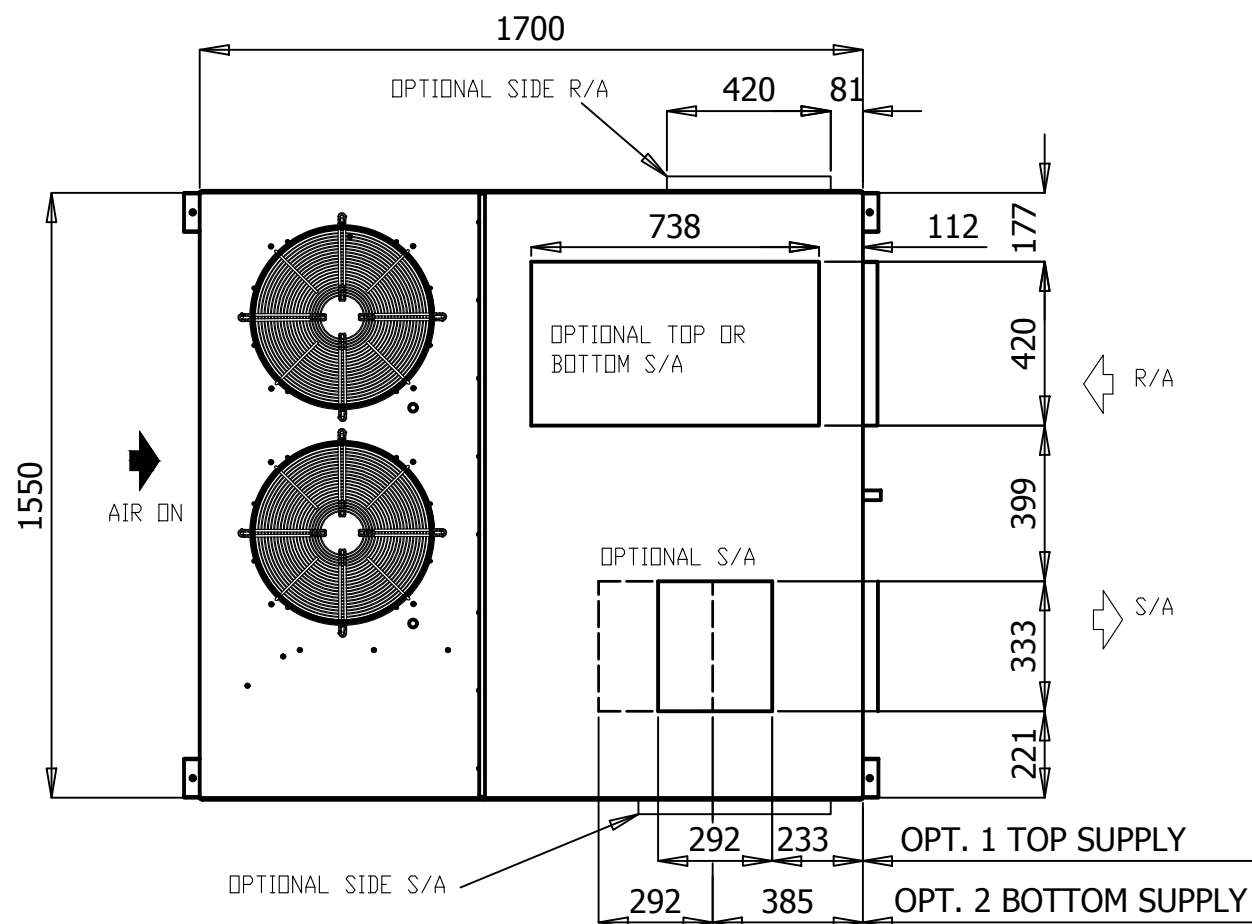

Fig 4. Air flow schematic of the right hand unit

CUSTOMER TO COMPLETE AND RETURN

CUSTOMER	PROJECT	UNIT REF	NAME / SIGN	DATE



PLAN

NOTES:

1. GENERAL ARRANGEMENT OF A HORIZONTAL AIR COOLED PACKED UNIT
2. POWER AND FIELD CABLE ENTRIES, 1 x 32 ϕ AND 2 x 25 ϕ
3. ELECTRICAL PANEL LOCATED BEHIND SERVICE ACCESS
4. CONDENSATE OUTLET 25 ϕ
5. UNIT BASE 4 x 16 ϕ FIXING POINTS
6. UNIT HAS 4 x 25.4 ϕ LIFTING POINTS
7. UNIT CONFIGURATION AS STANDARD IS REAR LEFT SUPPLY, REAR RIGHT RETURN, OTHER CONFIGURATIONS AVAILABLE.
8. UNIT CONFIGURATION CAN BE CONVERTED IN FIELD WITH OPTIONAL ACCESSORIES.

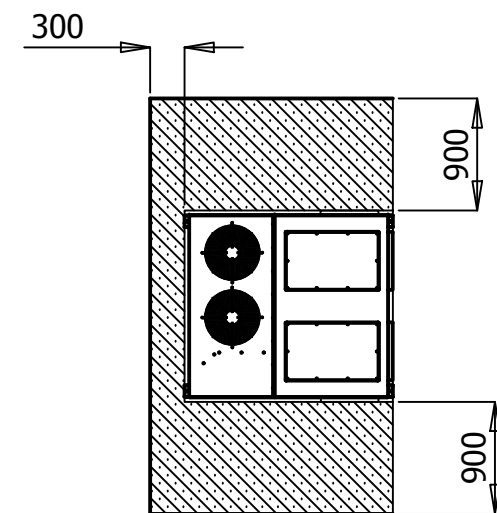

CLEARANCE DETAIL

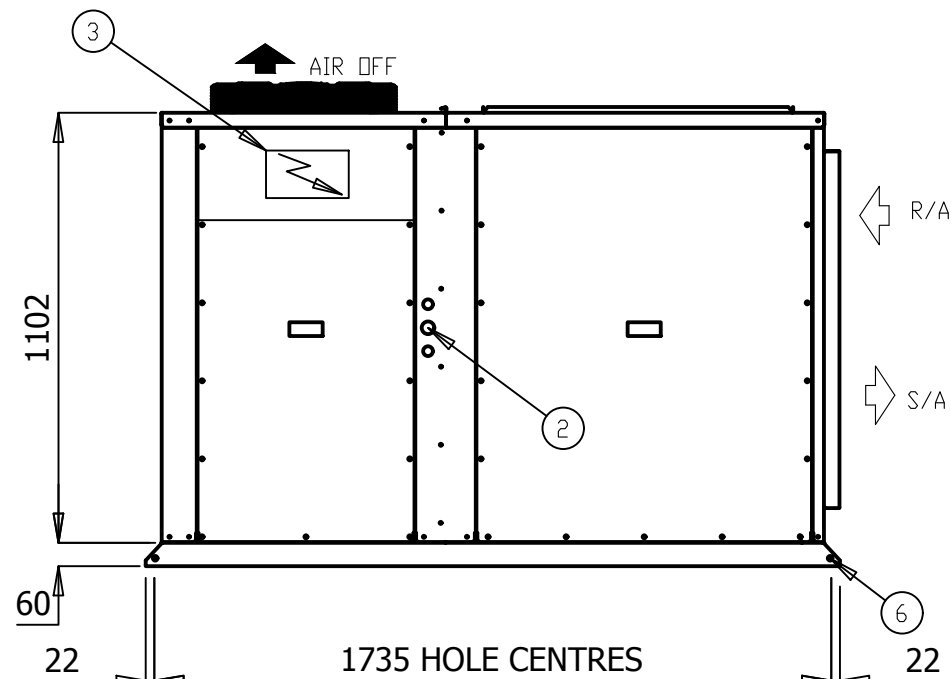

R/H ELEVATION

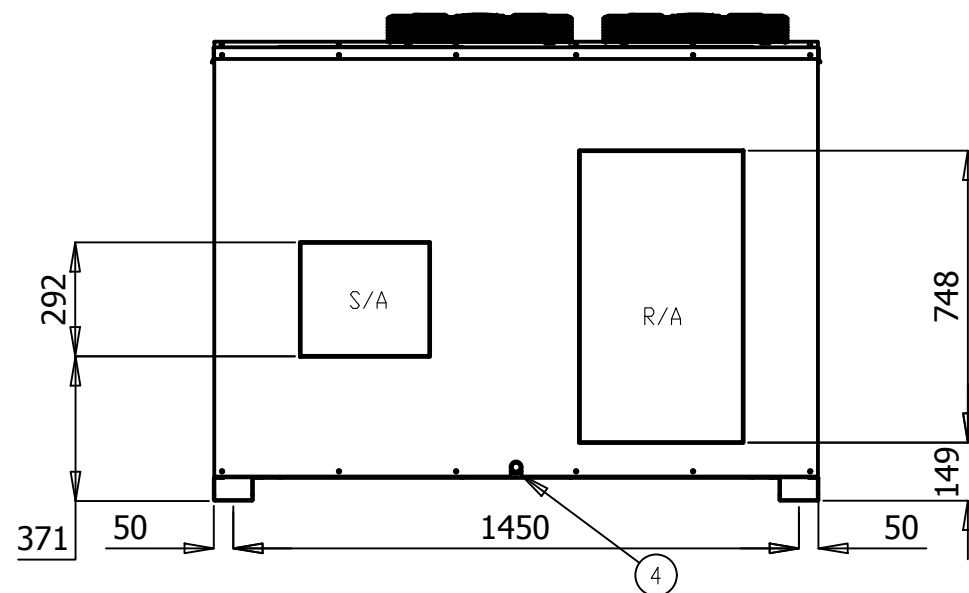

REAR ELEVATION

- ALL DIMENSIONS IN mm.
- GENERAL TOLERANCE ± 1 mm.
- DO NOT SCALE DRAWING.
- MASTER DRAWINGS ARE HELD ELECTRONICALLY. ANY COPY IS DEEMED UNCONTROLLED AND THEREFORE NOT NECESSARILY THE LATEST REVISION.
- ALL INFORMATION REMAINS THE PROPERTY OF THE COMPANY.

GENERAL ARRANGEMENT

P012AHR3SA- P015AHR3SA- P018AHR3SA- P020AHR3SA-

www.apacair.com.au

ABN: 74 005 138 769

REVISION	REVISED NAMEPLATE WITH APAC DETAILS				
		DRAWN	MT	DRAWING No.	A4
	ATLANTIC DR. KEYSBOROUGH VIC 3173 1300 555 545	DATE	10.03.17	GAD0081	
		SCALE	N.T.S.		
		CHECKED	HA	APP'D.	CM



TECHNICAL DATA SHEET

MODEL NUMBER		P012AHR3SA-	P015AHR3SA-	P018AHR3SA-	P020AHR3SA-	P023AHR3SA-	
MEPS REGISTRATION NUMBER		AAC3196	AAC3211	AAC3210	AAC3197	AAC3209	
CONDENSER SECTION	CAPACITY						
	Cooling	kW TOTAL*	12.57	15.54	17.43	20.53	22.89
		kW SENSIBLE*	9.70	12.09	13.58	15.99	18.20
		EER (kW / ikW)*	3.59	3.70	3.49	3.60	3.32
	Heating	kW TOTAL	11.90	14.70	16.70	20.60	22.50
		COP	3.66	3.87	3.71	3.81	3.63
	CAPACITY STEPS (%)		0/100	0/100	0/100	0/100	0/100
	COMPRESSOR						
	TYPE		SCROLL	SCROLL	SCROLL	SCROLL	SCROLL
	STARTER TYPE		D.O.L (Opt Soft/Start)	D.O.L (Opt Soft/Start)	D.O.L (Opt Soft/Start)	D.O.L (Opt Soft/Start)	D.O.L (Opt Soft/Start)
	PHASE		3Ø	3Ø	3Ø	3Ø	3Ø
	No. OFF		1	1	1	1	1
	PROTECTION DEVICES		HP SWITCH, LP SWITCH, MOTOR OVERLOAD'S				
	ALL COMPRESSORS HAVE		CRANKCASE HEATER				
	FAN						
	TYPE		AXIAL	AXIAL	AXIAL	AXIAL	AXIAL
	ikW (MAX INPUT)		0.19	0.19	0.19	0.27	0.27
	PHASE		1Ø	1Ø	1Ø	1Ø	1Ø
	No. OFF		2	2	2	2	2
	FAN SPEED CONTROL		VARIABLE SPEED	VARIABLE SPEED	VARIABLE SPEED	VARIABLE SPEED	VARIABLE SPEED
HEAT EXCHANGER							
TYPE		PLATE FIN COIL	PLATE FIN COIL	PLATE FIN COIL	PLATE FIN COIL	PLATE FIN COIL	
NOM. AIRFLOW l/s		-	-	-	-	-	
REFRIGERANT SYSTEM							
TYPE		R410A					
CHARGE PER CIRCUIT (KG)		3.95	5.3	5.7	7.3	6.8	
No. OF CIRCUITS		1	1	1	1	1	
REFRIGERANT CONTROL		TXV					
ALL SYSTEMS INCLUDE		DRIERS & SIGHT GLASSES					
EVAPORATOR SECTION	FAN						
	TYPE		CENTRIFUGAL	CENTRIFUGAL	CENTRIFUGAL	CENTRIFUGAL	CENTRIFUGAL
	ikW (MAX INPUT)		1.7	1.7	1.7	1.7	1.7
	PHASE		3Ø	3Ø	3Ø	3Ø	3Ø
	No. OFF		1	1	1	1	1
	FAN SPEED CONTROL		VARIABLE SPEED	VARIABLE SPEED	VARIABLE SPEED	VARIABLE SPEED	VARIABLE SPEED
	HEAT EXCHANGER						
TYPE		PLATE FIN COIL	PLATE FIN COIL	PLATE FIN COIL	PLATE FIN COIL	PLATE FIN COIL	
NOM. AIRFLOW l/s		625	800	890	1040	1190	
EXT STATIC pa		100 (ALL FANS ARE HIGH STATIC FANS. REFER TO FAN CURVES.)					
COMBINED SECTIONS	ELECTRICAL						
	MAINS POWER		415v / 3Ø / 50hz	415v / 3Ø / 50hz	415v / 3Ø / 50hz	415v / 3Ø / 50hz	415v / 3Ø / 50hz
	H.P. CUT OUT / IN kPa		4500 / 3450	4500 / 3450	4500 / 3450	4500 / 3450	4500 / 3450
	L.P. CUT OUT / IN kPa		175 / 345	175 / 345	175 / 345	175 / 345	175 / 345
	NOM. R.L.A. (TOTAL SYSTEM)		6.8	8.1	9.8	10.4	11.4
	MAX. F.L.A. (TOTAL SYSTEM)		12.3	14.6	16.1	20.0	20.0
	GENERAL						
	CABINET		GALVANISED SHEET STEEL				
	INSULATION		ALUMINIUM FOIL FACED POLYETHYLENE ACOUSTIC INSULATION				
	EXTERNAL FINISH		POLYESTER POWDER COAT - COLOUR LIGHT GREY AS STANDARD - OPTIONS AVAILABLE				
	DIMENSIONS						
	H X W X D (mm)		1162 x 1550 x 1700				
	WEIGHT						
	OPERATING KG		350	364	372	390	390
	SHIPPING KG		354	368	376	394	394
NOISE LEVELS [Based on condenser fan's sound data]							
Sound Power db(A)		61.7	61.7	61.7	66.6	66.6	

Note: Rated in accordance with Australian standard AS/NZS 3823.1:2012
 Performance excludes ikW of evaporator fan motor.
 R.L.A - Run Load Amps are based on current drawn at nominal conditions
 F.L.A - Full Load Amps are based on the overload settings [Max Current] of all Compressor and Fan Motor(s).

Date	Document #	Approved By	Revision
31/05/18	TDS0016	CM	F

NOTE: Due to continuous improvement Rinnai Australia Pty Ltd reserve the right to change details without notice.

FAN PERFORMANCE CURVE

P015AHR3SA-

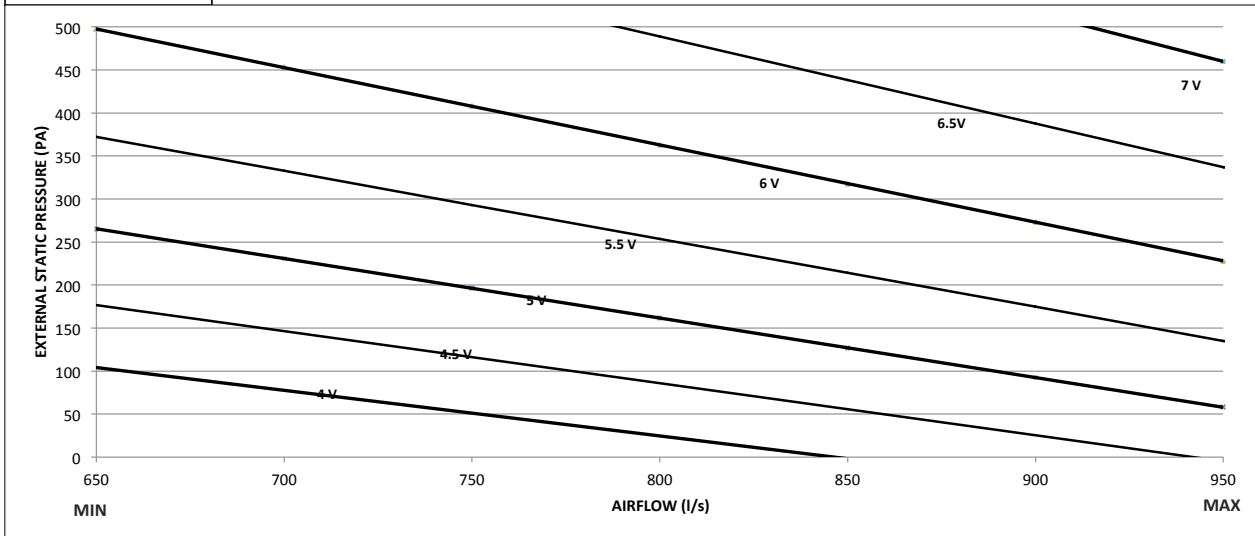

Note:

1. 4V, 4.5V, 5V, 5.5V, 6V, 6.5 V and 7V represents potentiometer voltage. Potentiometer can be adjusted to achieve desired flowrates.
2. Potentiometer voltage can be varied infinitely between 0 to 10V.

Date	Document #	Approved By	Revision
24/5/18	FPC0011	CM	D

NOTE: Due to continuous improvement Rinnai Australia Pty Ltd reserve the right to change details without notice.



SOUND DATA

MODEL NUMBER

P015AHR3SA-

Outdoor Fan

Sound Power Level dB(A)	Octave band Centre Frequency (hz), dB						
	125	250	500	1k	2k	4k	8k
61.7	66.4	58.6	54.6	56.6	56	50.5	41.9

Indoor Fan

Sound Power Level dB(A)	Air Flow (l/s)	Octave band Centre Frequency (hz), dB						
		125	250	500	1k	2k	4k	8k
75.2	800	58.3	65.6	67.8	70.9	68.4	66.4	65.4

Date	Document #	Approved By	Revision
30.05.18	SD0003	CM	B

NOTE: Due to continuous improvement Rinnai Australia Pty Ltd reserve the right to change details

